







20 000 706

- Bohrungsdurchmesser Seitenventil 32 mm
- Rosette 60 x 60 mm
- mit Warmkennzeichnung



	Champagne (22kt Gold)	20 000 706-47
	Chrom	20 000 706-00
	Platin gebürstet	20 000 706-06
	Dark Chrome	20 000 706-19
	Champagne gebürstet (22kt Gold)	20 000 706-46
	Dark Platinum gebürstet	20 000 706-99

20 000 706

mm [inches]

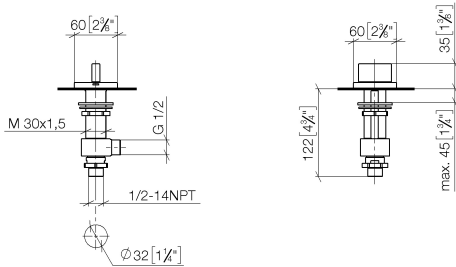

Durchflussdiagramm



Zertifikate

WRAS_2103001.

20 000 706

Ersatzteile für die
anderen
Oberflächenvarianten
finden Sie hier:
Chrom

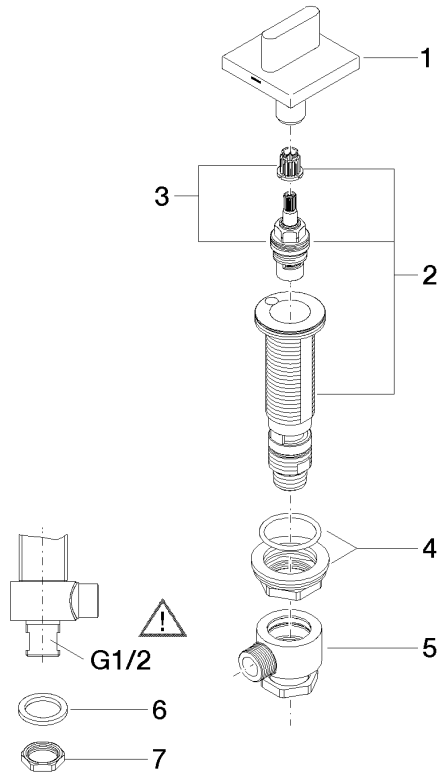

Ersatzteilstückliste

Nr.	Artikelnummer	Benennung	Verbaumenge	Lieferzeit
1	90 20 70 051 05-47	Griff (hot)	1	30
2	04 17 11 058 32 90	Seitenteil	1	2
3	90 90 03 132 00 90	Oberteil	1	2
4	04 23 10 032 78 90	Befestigungssatz	1	2
5	04 17 11 023 10 90	Verteiler	1	2
6	90 23 30 040 00-47	Verschraubung	1	30
7	09 30 11 059 90	Scheibe	1	2
8	09 23 10 012 90	Mutter	1	2